

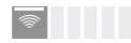

**Quadratplatten System S 33 Einlegesystem für sichtbare T-Profile**

	Format mm	Stk. / Pack	m2 / Pack	Pack / Palette
<b>Quadratplatte - ungelocht</b>	625 x 625	14	5,46	48

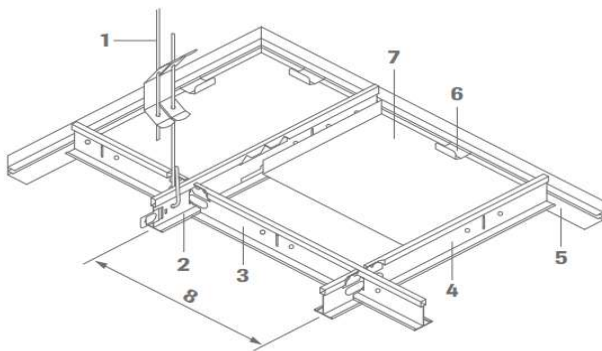

$\alpha_w = 0,05$  | NRC = 0,05

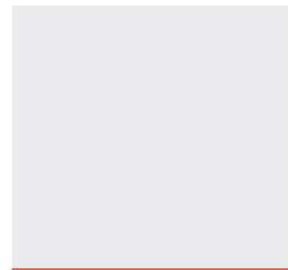

**L0 ungelocht**

**Qualität:** verzinktes Stahlblech, ca. 0.5 mm dick  
**Farbe:** weiss ähnl. **RAL 9003**

**Unterkonstruktion zum OWA S 33 Einlegesystem**

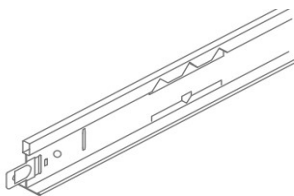

	Artikel Nr.	Stk. / Pack
<b>Tragprofil T-24/38</b> Länge 3750 mm, weiss ähnl. RAL 9003	45	25

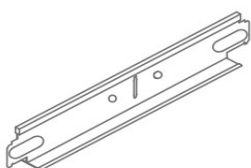

	Artikel Nr.	Stk. / Pack
<b>Querprofil T-24/32</b> Länge 625 mm, weiss ähnl. RAL 9003	46	75

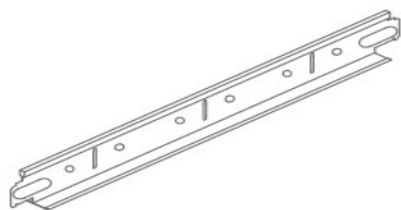

**Querprofil T-24/32**

Länge 1250 mm, weiss ähnl. RAL 9003

Artikel Nr.

Stk. / Pack

47

50



**Schnellabhänger m. HA-Draht vorm.**

Länge mm

Artikel Nr.

Stk. / Pack

125

12/125

100

250

12/250

100



**Ösendraht**

Abhängedraht mit Öse  
Tragfähigkeit 250 N / 25 kg  
(in Abhängigkeit zum eingesetz-  
ten Abhängerunterteil)

Länge mm

Artikel Nr.

Stk. / Pack

125

14/12

100

250

14/25

100

375

14/37

100

500

14/50

100

750

14/75

100

1000

14/100

100

1250

14/125

100

1500

14/150

100

1750

14/175

100

2000

14/200

100

2500

14/250

100

3000

14/300

100

	Artikel Nr.	Stk. / Pack
<b>Einfachwandwinkel-F 25/25 Alu</b> Länge 4000 mm, weiss ähnl. RAL 9003	50F-4000	10

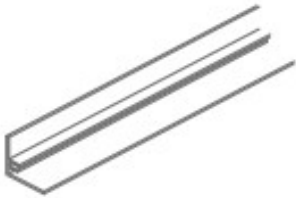

	Artikel Nr.	Stk. / Pack
<b>Wandfeder zu Einfachwandwinkel-F</b>	5220	100

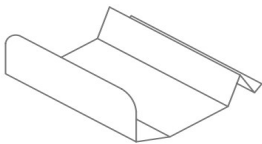

**Metall-Rechteckplatte H2 Hängesystem / freigespannt - H28**

	Format mm	Platte / Pack	m2 / Pack	Pack / Palette
<b>Rechteckplatten - ungelocht</b>	1750 x 400	2	1,4	48
	2000 x 400	2	1,6	48
	2250 x 400	2	1,8	48
	2500 x 400	2	2,0	48
	2750 x 400	2	2,2	48
	3000 x 400	2	2,4	48

**Qualität:**  
**Farbe:**

Stahlblech 0.62 mm  
weiss ähnl. **RAL 9010**

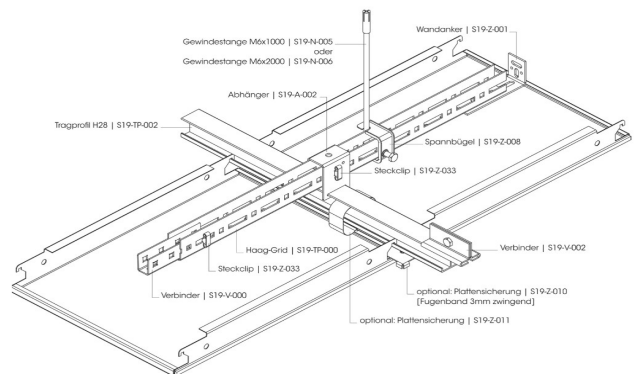
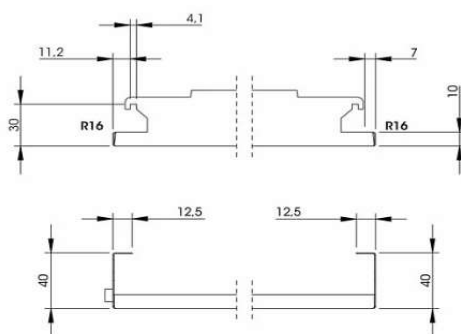

Unterkonstruktion zum System H2 Hängesystem / freigespannt - H28

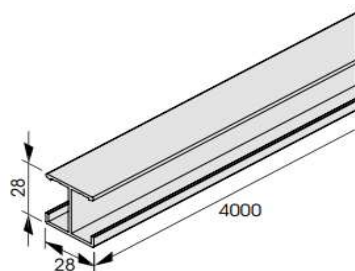

**Tragprofil H-28**  
Länge 4000 mm

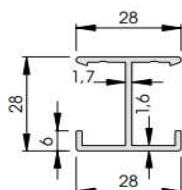

Artikel Nr.

Stk. / Bund

S19-02-0228

10

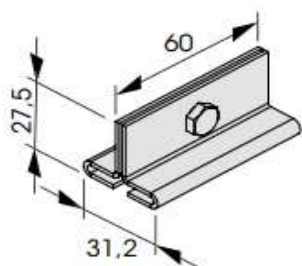

**Verbinder zu H-28/H31**

Artikel Nr.

Stk. / Pak

S19-02-0201

100

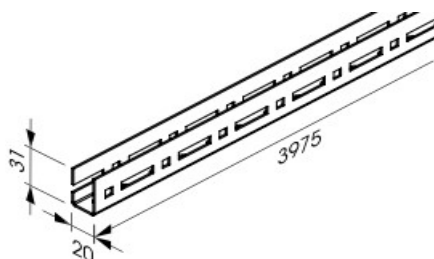

**U-Profil GRID 20/30/20 gelocht**  
Länge 3975 mm

Artikel Nr.

Stk. / Bund

S19-TP-000

6

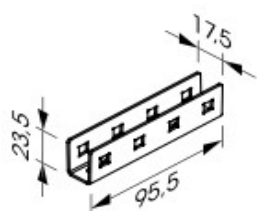

**Verbinder zu U-Profil GRID**

Artikel Nr.

Stk. / Pak

S19-V-000

100

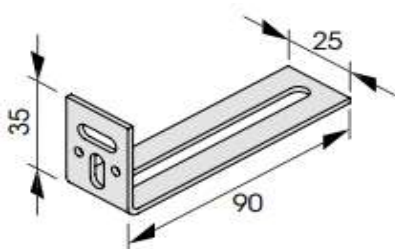

**Wandanker WA**

Artikel Nr.

Stk. / Pak

S19-WAW-0102

100

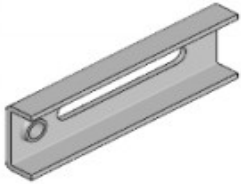

	Artikel Nr.	Stk. / Pak
<b>Positionierungselement M6</b>	S19-POS-E-M6	100

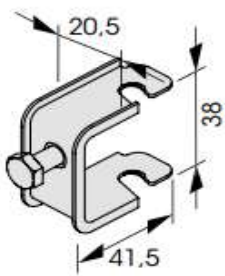

	Artikel Nr.	Stk. / Pak
<b>Spannbügel</b>	S19-SPANN-BÜGEL	100



	Artikel Nr.	Stk. / Pak
<b>Klemmclips H28/31 zu U-Profil</b>	S19-KL-H28/35	50

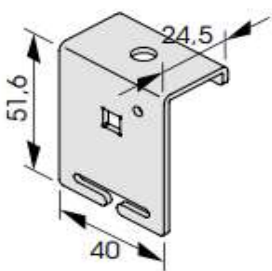

	Artikel Nr.	Stk. / Pak
<b>Abhänger zu H-28/H-31</b>	S19-A-002	100



	Artikel Nr.	Stk. / Pak
<b>Abhänger zu H-28/H-31 f. OE/GEW</b>	S19-S02-HT-OEAH	50

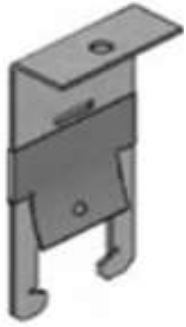

	Artikel Nr.	Stk. / Pak
<b>Abhänger zu H-28/H-31 f. GEW</b>	S19-S02-HT-AH	50

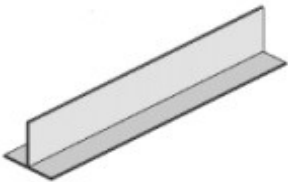

	Artikel Nr.	Stk. / Bund
<b>T-Profil 40/40 mm Alu</b> Länge 4000 mm, weiss ähnl. RAL 9010	S19-ALT-40-40	5



	Artikel Nr.	Stk. / Pak
<b>Klemmfeder zu Randwinkel KF</b>	S19-FED-KF-0034	100



	Artikel Nr.	Stk. / Bund
<b>Einfachwandwinkel 20/50 Alu</b> Länge 4000 mm, weiss ähnl. RAL 9010	S19-EW-50x20-9010	10

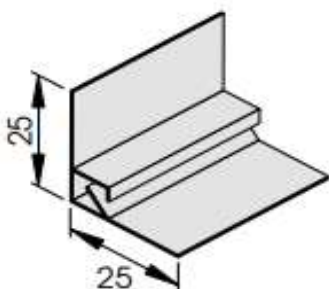

	Artikel Nr.	Stk. / Bund
<b>Einfachwandwinkel KF Alu</b> mit Sicherungsschlitz Länge 4000 mm, weiss ähnl. RAL 9010	S19-EW-KF-RAL	5

Artikel Nr.

Stk. / Bund

**Stufenwandwinkel KF Alu**

S19-DW-KF-RAL

5

mit Sicherungsschlitz

Länge 4000 mm, weiss ähnl. RAL 9010

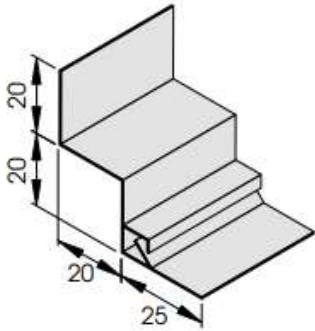

Artikel Nr.

Stk. / Bund

**Bilder-Doppelrandwinkel KF Alu**

S19-BDW-KF-RAL

5

mit Sicherungsschlitz

Länge 4000 mm, weiss ähnl. RAL 9010

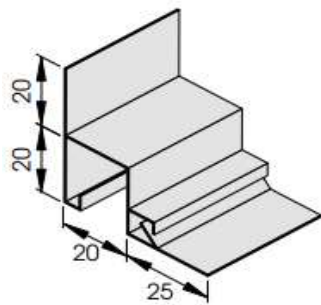

Artikel Nr.

Stk. / Bund

**Gewindestange M6**

8021

50

Länge 2000 mm



Grösse

Artikel Nr.

Stk. / Pack

**Muttern 6-Kant**

M6

636006000

200

M8

636008000

100

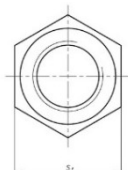
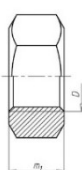

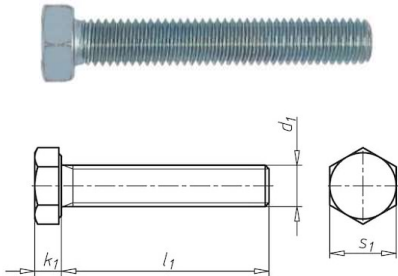
**METALLPLATTEN**

	Grösse	Artikel Nr.	Stk. / Pack
<b>SBS 6-Kant</b>	16 mm M6	S19-SCHR-M6x16-KT	100
	20 mm M8	636108000	100
	40 mm M6	636106040	100

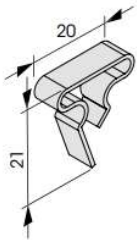

	Artikel Nr.	Stk. / Pack
<b>Steckclip</b>	S19-CLIPS-06	100



	Artikel Nr.	Stk. / Pack
<b>Fugenband P610</b>	302001009	5

3x9 mm, 10 lfm/Roll, **anthrazit**