

**OWA**

**Quadratplatten System S 33 Einlegesystem für sichtbare T-Profile**

|                                  | Format mm | Stk. / Pack | m2 / Pack | Pack / Palette |
|----------------------------------|-----------|-------------|-----------|----------------|
| <b>Quadratplatte - ungelocht</b> | 625 x 625 | 14          | 5,46      | 48             |

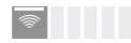
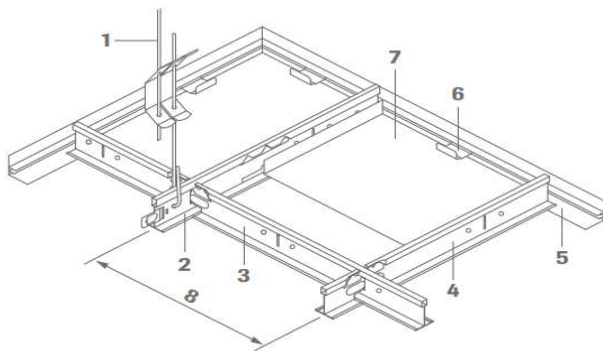

$\alpha_w = 0,05$  | NRC = 0,05

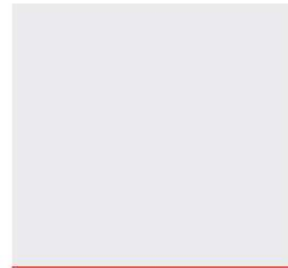

**L0 ungelocht**

**Qualität:** verzinktes Stahlblech, ca. 0.5 mm dick  
**Farbe:** weiss ähnl. **RAL 9003**

**Unterkonstruktion zum OWA S 33 Einlegesystem**

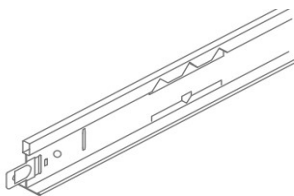

|  | Artikel Nr. | Stk. / Pack |
|--|-------------|-------------|
| <b>Tragprofil T-24/38</b><br>Länge 3750 mm, weiss ähnl. RAL 9003 | 45          | 25          |

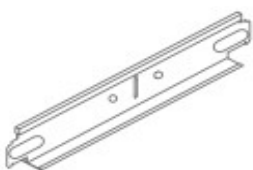

|   | Artikel Nr. | Stk. / Pack |
|---|-------------|-------------|
| <b>Querprofil T-24/32</b><br>Länge 625 mm, weiss ähnl. RAL 9003 | 46          | 75          |

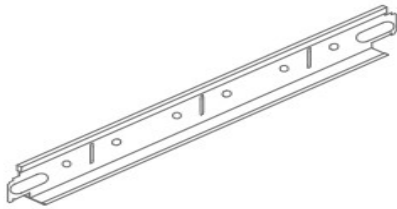

**Querprofil T-24/32**

Länge 1250 mm, weiss ähnl. RAL 9003

Artikel Nr.

Stk. / Pack

47

50



**Schnellabhänger m. HA-Draht vorm.**

Länge mm

Artikel Nr.

Stk. / Pack

125

12/125

100

250

12/250

100



**Ösendraht**

Abhängedraht mit Öse  
Tragfähigkeit 250 N / 25 kg  
(in Abhängigkeit zum eingesetz-  
ten Abhängerunterteil)

Länge mm

Artikel Nr.

Stk. / Pack

125

14/12

100

250

14/25

100

375

14/37

100

500

14/50

100

750

14/75

100

1000

14/100

100

1250

14/125

100

1500

14/150

100

1750

14/175

100

2000

14/200

100

2500

14/250

100

3000

14/300

100

|   | Artikel Nr. | Stk. / Pack |
|---|-------------|-------------|
| <b>Einfachwandwinkel-F 25/25 Alu</b><br>Länge 4000 mm, weiss ähnl. RAL 9003 | 50F-4000    | 10          |



|   | Artikel Nr. | Stk. / Pack |
|---|-------------|-------------|
| <b>Wandfeder zu Einfachwandwinkel-F</b> | 5220        | 100         |

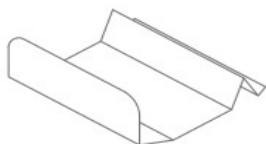

**Metall-Rechteckplatte H2 Hängesystem / freigespannt - H28**

|                                    | Format mm  | Platte / Pack | m2 / Pack | Pack / Palette |
|------------------------------------|------------|---------------|-----------|----------------|
| <b>Rechteckplatten - ungelocht</b> | 1750 x 400 | 2             | 1,4       | 48             |
|                                    | 2000 x 400 | 2             | 1,6       | 48             |
|                                    | 2250 x 400 | 2             | 1,8       | 48             |
|                                    | 2500 x 400 | 2             | 2,0       | 48             |
|                                    | 2750 x 400 | 2             | 2,2       | 48             |
|                                    | 3000 x 400 | 2             | 2,4       | 48             |

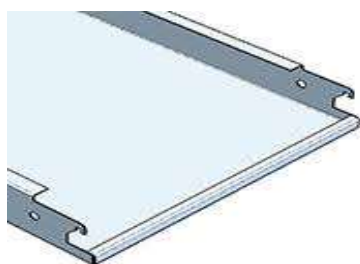

**Qualität:**  
**Farbe:**

Stahlblech 0.62 mm  
weiss ähnl. **RAL 9010**

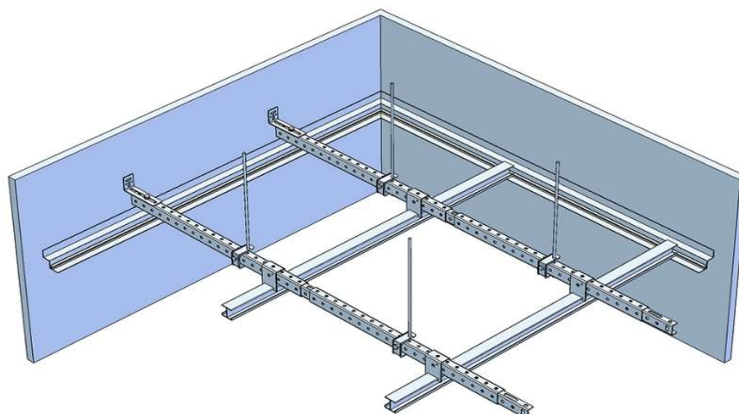

Unterkonstruktion zum System H2 Hängesystem / freigespannt - H28

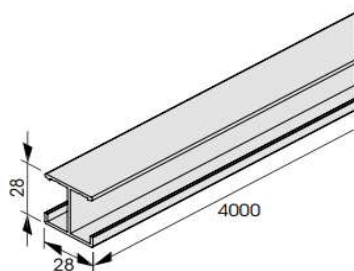

**Tragprofil H-28**  
Länge 4000 mm

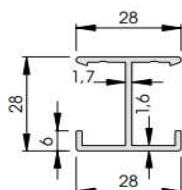

Artikel Nr.

Stk. / Bund

S-19-02-0228

10

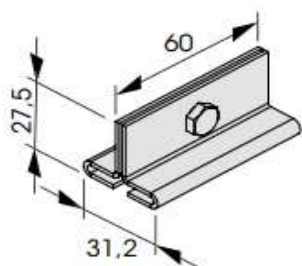

**Verbinder zu H-28/H31**

Artikel Nr.

Stk. / Pak

S-19-02-0201

100

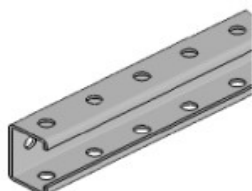

**U-Profil 20/30/20 gelocht**  
Länge 4000 mm

Artikel Nr.

Stk. / Bund

S-19-02-0201

6



**Verbinder zu U-30**

Artikel Nr.

Stk. / Pak

S19-PRIM-V

100

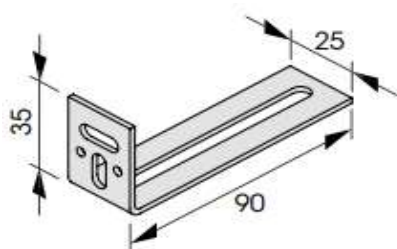

**Wandanker WA**

Artikel Nr.

Stk. / Pak

S19-WAW-0102

100

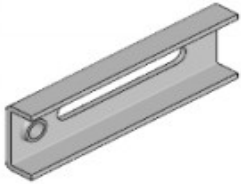

|                                  | Artikel Nr.  | Stk. / Pak |
|----------------------------------|--------------|------------|
| <b>Positionierungselement M6</b> | S19-POS-E-M6 | 100        |

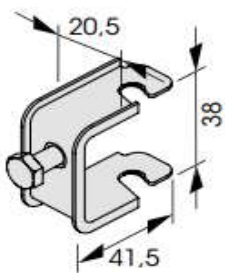

|                   | Artikel Nr.     | Stk. / Pak |
|-------------------|-----------------|------------|
| <b>Spannbügel</b> | S19-SPANN-BÜGEL | 100        |



|                                      | Artikel Nr.   | Stk. / Pak |
|--------------------------------------|---------------|------------|
| <b>Klemmclips H28/31 zu U-Profil</b> | S19-KL-H28/35 | 50         |

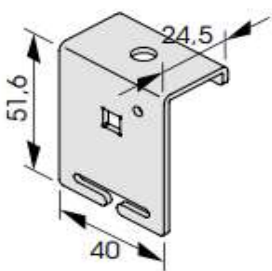

|                              | Artikel Nr. | Stk. / Pak |
|------------------------------|-------------|------------|
| <b>Abhänger zu H-28/H-31</b> | S19-A-002   | 100        |



|  | Artikel Nr.     | Stk. / Pak |
|--|-----------------|------------|
| <b>Abhänger zu H-28/H-31 f. OE/GEW</b> | S19-S02-HT-OEAH | 50         |

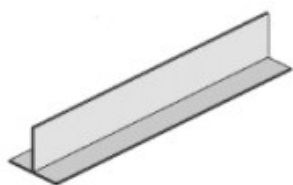

**T-Profil 40/40 mm Alu**

Länge 4000 mm, weiss ähnl. RAL 9010

Artikel Nr.

Stk. / Bund

S19-ALT-40-40

10



**Klemmfeder zu Randwinkel KF**

Artikel Nr.

Stk. / Pak

S19-FED-KF-0034

100

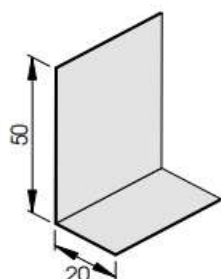

**Einfachwandwinkel 20/50 Alu**

Länge 4000 mm, weiss ähnl. RAL 9010

Artikel Nr.

Stk. / Bund

S19-EW-50x20-9010

10

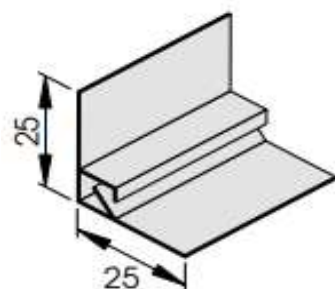

**Einfachwandwinkel KF Alu**

mit Sicherungsschlitz

Länge 4000 mm, weiss ähnl. RAL 9010

Artikel Nr.

Stk. / Bund

S19-EW-KF-RAL

5

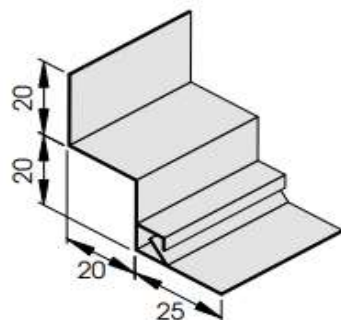

**Stufenwandwinkel KF Alu**

mit Sicherungsschlitz

Länge 4000 mm, weiss ähnl. RAL 9010

Artikel Nr.

Stk. / Bund

S19-DW-KF-RAL

5

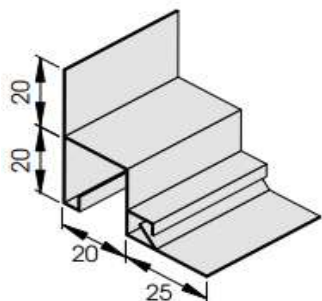

**Bilder-Doppelrandwinkel KF Alu**

mit Sicherungsschlitz

Länge 4000 mm, weiss ähnl. RAL 9010

Artikel Nr.

Stk. / Bund

S19-BDW-KF-RAL

5



**Gewindestange M6**

Länge 2000 mm

Artikel Nr.

Stk. / Bund

8021

50

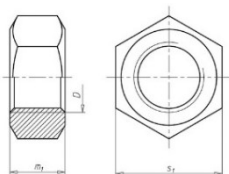

**Muttern 6-Kant**

Grösse

Artikel Nr.

Stk. / Pack

M6

636006000

200

M8

636008000

100

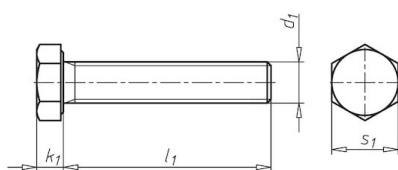

**SBS 6-Kant**

Grösse

Artikel Nr.

Stk. / Pack

16 mm M6

S19-SCHR-M6x16-KT

100

20 mm M8

636108000

100

40 mm M6

636106040

100

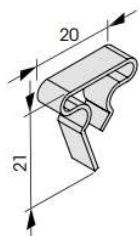

|                  | Artikel Nr.  | Stk. / Pack |
|------------------|--------------|-------------|
| <b>Steckclip</b> | S19-CLIPS-06 | 100         |



|   | Artikel Nr. | Stk. / Pack |
|---|-------------|-------------|
| <b>Fugenband P610</b><br>3x9 mm, 10 lfm/Roll, anthrazit | 302001009   | 5           |