

# OWA

	Kante	Abm. mm	Stk. / Pack	Pack / Palette
<b>Bolero</b>	Kte 3	625/625/15	12	40
<b>Brillianto A</b>	Kte 3	625/625/15	12	40
<b>Sinfonia</b>	Kte 3	625/625/15	12	40
<b>Cosmos/N *</b>	Kte 3	625/625/15	12	40
<b>Harmony</b>	Kte 3	625/625/15	12	40
<b>Harmony</b>	Kte 3	1250/625/15	10	24
<b>Harmony Smart</b>	Kte 3	625/625/14	12	44
<b>Reg. gelocht °</b>	Kte 3	625/625/15	12	40
<b>Schlicht</b>	Kte 3	625/625/15	12	40
<b>Sternbild</b>	Kte 3	625/625/15	12	40
<b>Sternbild</b>	Kte 3	1250/625/15	10	24
<b>Sternbild Smart</b>	Kte 3	625/625/14	12	44
<b>Sternbild</b>	Kte 6	625/625/15	10	48

° gelocht = Lochdurchmesser ca. 4.5 mm

\* N = mit Nadelung

Brillianto A "vlieskaschier"



Kante 3

Sinfonia "vlieskaschier"

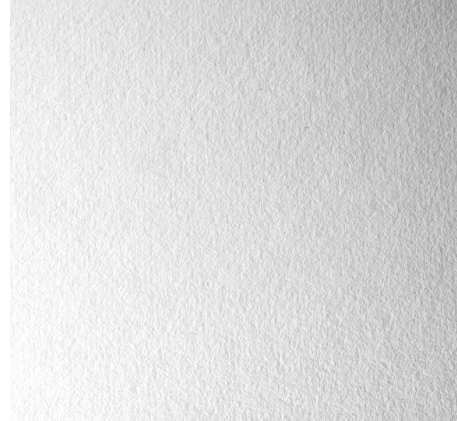

Kante 3

Bolero



Kante 3

Cosmos/N \*



Kante 3

Harmony smart 14 mm



Kante 3

Harmony



Kante 3

Schlicht



Kante 3

Regl. gelocht °

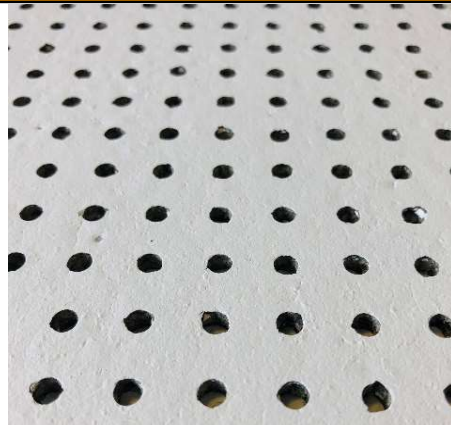

Kante 3

Sternbild smart 14 mm



Kante 3

Sternbild



Kante 6

Kante 3

Alle Platten-Ausführungen ähnl. **RAL 9003**

° gelocht = Lochdurchmesser **ca. 4.5 mm**

Abstand von Lochmitte zu Lochmitte **ca. 12.5 mm**

**Kante 3** Rand ungelocht, Randabstand bis zur ersten Reihe ca. 14 mm

\* N = mit Nadelung

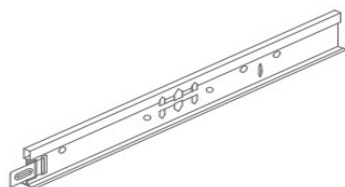

	Länge mm	Artikel Nr.	Stk. / Pack
<b>Tragprofil cliq</b>	3125	45/15cliq MR-3125	20

System 15 cliq / 15a cliq

Profilbreite 15 mm  
Höhe 38 mm  
weiss ähnl. **RAL 9003**

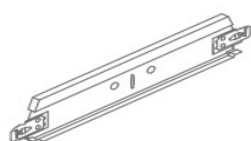

	Länge mm	Artikel Nr.	Stk. / Pack
<b>Querprofil cliq</b>	625	46/15cliq CT-625	60

System 15 cliq / 15a cliq

Profilbreite 15 mm  
Höhe 38 mm  
weiss ähnl. **RAL 9003**

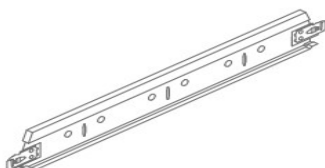

	Länge mm	Artikel Nr.	Stk. / Pack
<b>Querprofil cliq</b>	1250	47/15cliq CT-1250	60

System 15 cliq / 15a cliq

Profilbreite 15 mm  
Höhe 38 mm  
weiss ähnl. **RAL 9003**

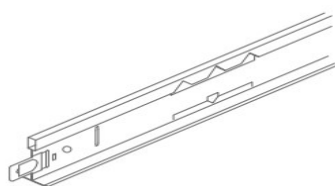

	Länge mm	Artikel Nr.	Stk. / Pack
<b>Tragprofil</b>	3750	45 G-3750	25
	3700	45 G-3700	25

System S 3 / S 3a

Profilbreite 24 mm  
Höhe 38 mm  
weiss ähnl. **RAL 9003**

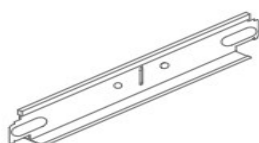

	Länge mm	Artikel Nr.	Stk. / Pack
<b>Querprofil</b>	625	46 G-625	75
	600	46 G-600	75

System S 3 / S 3a

Profilbreite 24 mm  
Höhe 32 mm  
weiss ähnl. **RAL 9003**

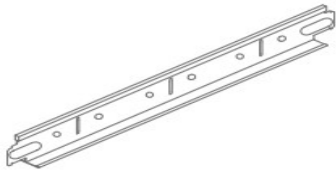

	Länge mm	Artikel Nr.	Stk. / Pack
<b>Querprofil</b>	1250	47 G-1250	50
System S 3 / S 3a	1200	47 G-1200	50

Profilbreite 24 mm  
 Höhe 32 mm  
 weiss ähnl. **RAL 9003**



	Flanschdicke	Artikel Nr.	Stk. / Pack
<b>Flanschabhängiger</b>	4-8 mm	8013-24-V	100
	8-14 mm	8013-58-V	100



	Artikel Nr.	Stk. / Pack
<b>Spannabhängiger 12/45</b>	12/45	100

Passend zu Tragprofil Nr. 45 und 45/15 cliq.



	Artikel Nr.	Stk. / Pack
<b>Spannabhängiger 12/10</b>	12/10	100

Passend zu Abhängprofil Nr. 70.



	Artikel Nr.	Stk. / Pack
<b>Doppelspannfeder</b>	12	100



**Schnellabhänger m. HA-Draht vorm.**

Länge mm	Artikel Nr.	Stk. / Pack
125	12/125	100
250	12/250	100



**Ösendraht**

Abhängedraht mit Öse  
Tragfähigkeit 250 N / 25 kg  
(in Abhängigkeit zum eingesetzten Abhängerunterteil)

Länge mm	Artikel Nr.	Stk. / Pack
125	14/12	100
250	14/25	100
375	14/37	100
500	14/50	100
750	14/75	100
1000	14/100	100
1250	14/125	100
1500	14/150	100
1750	14/175	100
2000	14/200	100
2500	14/250	100
3000	14/300	100

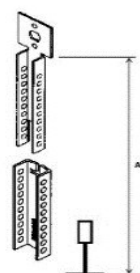

**Kurzabhänger Nonius 2-teilig**

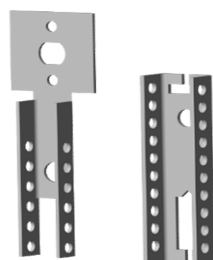

Länge A mm	Artikel Nr.	Stk. / Pack
78-120	09/45-5	100
90-142	09/45-7	100
120-170	09/45-11	100

**A= Justierbereich Unterkante Rohdecke bis Unterkante T-Tragschiene**

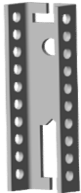

	Artikel Nr.	Stk. / Pack
<b>Nonius-Unterteil</b>	09/45	100

zu Nr. 45 & 45/15

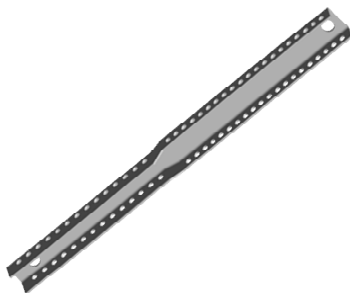

	Artikel Nr.	Stk. / Pack
<b>Nonius-Kupplung</b>	229200000	100

zur Verlängerung von Noniusabhängungen um maximal 160 mm  
 Tragfähigkeit 400 / 40 kg  
 (in Abhängigkeit zum eingesetzten Abhängeunterteil)  
 Länge 200 mm



	Artikel Nr.	Stk. / Pack
<b>Noniusabhänger zu Nr. 70</b>	17/10	100

Passend zu Abhängeprofil Nr. 70.

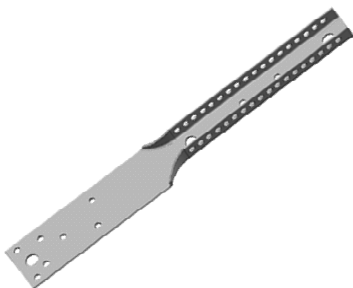

	Artikel Nr.	Stk. / Pack
<b>Noniusabhänger f. Anschraubm.</b>	17/81	100

Noniusabhänger , **gerade** für Holzmontagelatten  
 Tragfähigkeit 150 N / 15 kg  
 Länge 190 mm



	Artikel Nr.	Stk. / Pack
<b>Nonius-Unterteil f. Dreieckausst.</b>	17/80	100

für Dreieckaussteifungen  
**45°**-abgewinkelt, für Queraussteifungen  
 Tragfähigkeit 400 N / 40 kg  
 (in Abhängigkeit zum eingesetzten Abhängerunterteil)  
 Länge 180 mm





Tragfähigkeit 400 N / 40 kg  
(in Abhängigkeit zum  
eingesetzten Abhängerunterteil)

Länge mm	Artikel Nr.	Stk. / Pack
85	16/15	100
135	16/20	100
235	16/30	100
340	16/40	100
440	16/50	100
540	16/60	100
640	16/70	100
740	16/80	100
840	16/90	100
940	16/100	100
1040	16/110	25
1140	16/120	25
1240	16/130	25
1340	16/140	25
1440	16/150	25
1540	16/160	25
1640	16/170	25
1740	16/180	25
1840	16/190	25
1940	16/200	25
2940	16/300	25



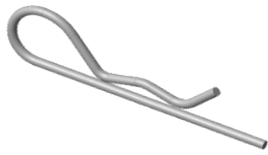

	Artikel Nr.	Stk. / Pack
<b>Sicherungsstift</b>	76	100

Tragfähigkeit 400 N / 40 kg  
 (in Abhängigkeit zum eingesetzten Abhängeunterteil)  
 Länge 72 mm

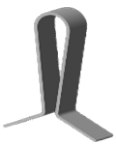

	Höhe mm	Artikel Nr.	Stk. / Pack
<b>Druckfeder</b>	30	44	500

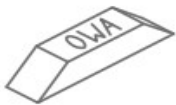

	Höhe / Sichtbreite	Artikel Nr.	Stk. / Pack
<b>Contura-Füllstück K6</b>	6 / 24 mm	42/7	100
	8 / 24 mm	42/24	100



	Flansch mm	Artikel Nr.	Stk. / Pack
<b>Innenecken weiss</b>	19	54	50
	24	54/1	50

zu Nr. 50G



	Flansch mm	Artikel Nr.	Stk. / Pack
<b>Aussenecken weiss</b>	19	54/50	50
	24	54/50/1	50

zu Nr. 50G

**UNTERKONSTRUKTION**

**Nonius-Druckabhänger zu BR**

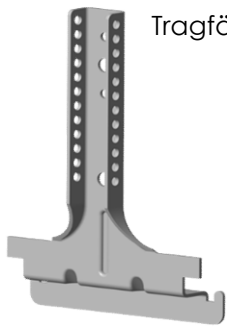

zu Profil Nr. 80/....  
Tragfähigkeit 400 N / 40 kg

BR Breite mm	Artikel Nr.	Stk. / Pack
50	79/50	100
75	79/75	100
100	79/100	100
125	79/125	100
150	79/125	100

**Bandrasterprofil**

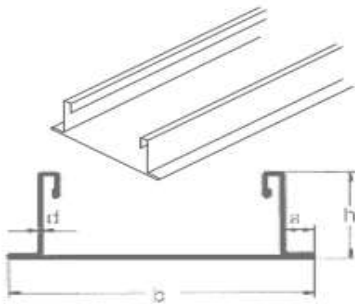

Abmessungen: mm

b	h	d	a
50	35	0,6	11,5
75	35	0,6	11,5
100	35	0,6	11,5
125	35	0,7	11,5
150	35	0,7	11,5

BR Breite mm	Artikel Nr.	Stk. / Bund
50	80/50G	8
75	80/75G	8
100	80/100G	8
125	80/125G	4
150	80/150G	4

**Kuplung zu BR**

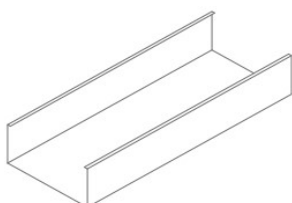

zu Nr. 80/....

BR Breite mm	Artikel Nr.	Stk. / Pack
50	82/50G	25
75	82/75G	25
100	82/100G	25
125	82/125G	25
150	82/150G	25

**Querverbindung zu BR**

zu Nr. 80/...

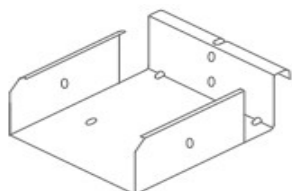

BR Breite mm	Artikel Nr.	Stk. / Pack
50	81/50G	25
75	81/75G	25
100	81/100G	25
125	81/125G	25
150	81/150G	25

**Wandanker verz. zu BR**

zu Nr. 80/...

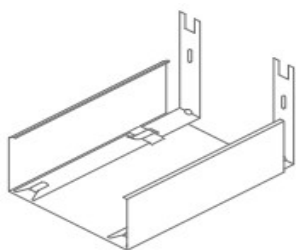

BR Breite mm	Artikel Nr.	Stk. / Pack
50	75/50G	25
75	75/75G	25
100	75/100G	25
125	75/125G	25
150	75/150G	25

**Einfachwandwinkel 24/19 Stahl**

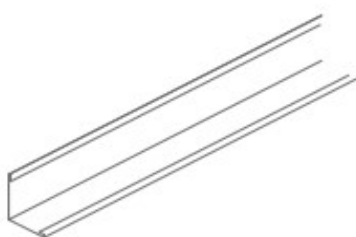

Höhe 24 mm  
Breite 19 mm  
weiss ähnl. **RAL 9003**

Länge mm	Artikel Nr.	Stk. / Pack
3050	50G-3050	40

**Stufenwandwinkel 25/20/20/20**

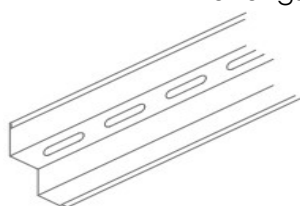

mit Lüftungsschlitze

Höhe 45 mm  
Gesamtbreite 40 mm  
Sichtbreite 20 mm  
weiss ähnl. **RAL 9003**

Länge mm	Artikel Nr.	Stk. / Pack
3000	56/35	15

	Länge mm	Artikel Nr.	Stk. / Bund
<b>Einfachwandwinkel 20/20 Alu</b>	3000	109/2	10

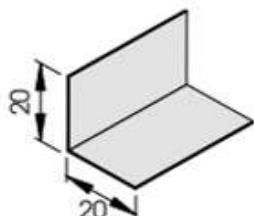

Höhe 20 mm  
Breite 20 mm  
weiss ähnl. **RAL 9010**

	Länge mm	Artikel Nr.	Stk. / Bund
<b>Stufenwandwinkel 20/20/20/20 Alu</b>	3000	110/2	10

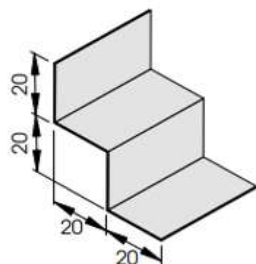

Höhe 40 mm  
Gesamtbreite 40 mm  
Sichtbreite 20 mm  
weiss ähnl. **RAL 9010**

	Länge mm	Artikel Nr.	Stk. / Bund
<b>Einfachwandwinkel 20/50 Alu</b>	4000	S19-EW-50x20-9010	10

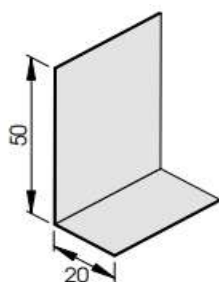

Höhe 50 mm  
Breite 20 mm  
weiss ähnl. **RAL 9010**